

SOFTDRIVE SAF 202



OPERATING INSTRUCTIONS

S2S ELECTRONICS LTD
Turnbridge Mills
Quay Street
Huddersfield HD1 6QX
Tel: 01484 530893
Fax: 01484 550500

www.softstartdirect.com



SAF 202

Mounting

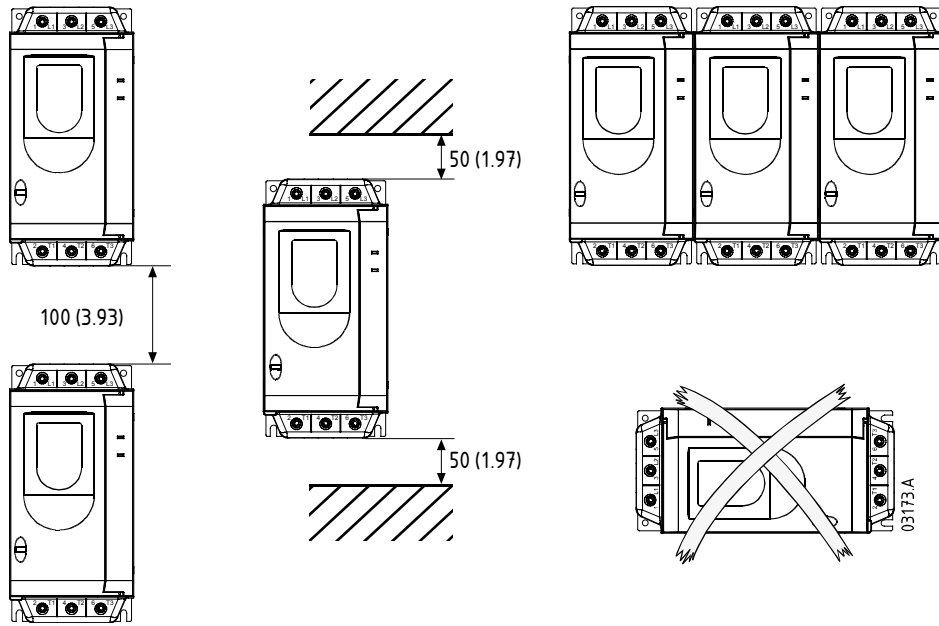

mm (inch)



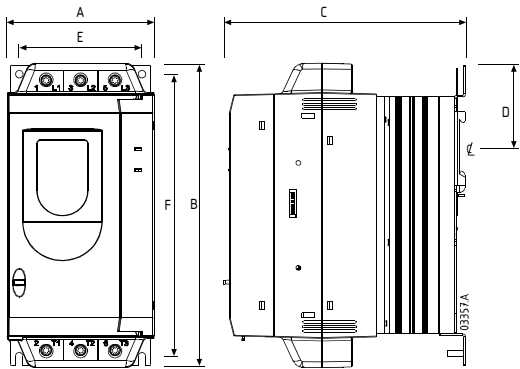





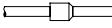
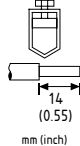

Dimensions

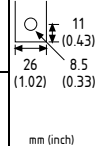
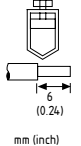

SAF 202	A	B	C	D	E	F
SAF 202-015	98	203	165	55	82	188
SAF 202-022	(3.86)	(7.99)	(6.50)	(2.17)	(3.23)	(7.40)
SAF 202-030						
SAF 202-037	145	215	193	-	124	196
SAF 202-045	(5.71)	(8.46)	(7.60)		(4.88)	(7.72)
SAF 202-075						
SAF 202-090	202	240	214	-	160	204
SAF 202-110	(7.95)	(9.45)	(8.43)		(6.30)	(8.03)

mm (inch)

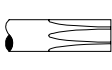
Cable Termination

	mm ² (AWG)				mm ² (AWG)			
	SAF 200-015 ~ SAF 200-030		SAF 200-037 ~ SAF 200-055		SAF 200-075 ~ SAF 200-110			
	10 - 35 (8 - 2)		25 - 50 (4 - 1/0)		N.A.		0.14 - 1.5 (26 - 16)	
	10 - 35 (8 - 2)		25 - 50 (4 - 1/0)		N.A.		0.14 - 1.5 (26 - 16)	
	Torx (T20) 3 Nm 2.2 ft-lb		Torx (T20) 4 Nm 2.9 ft-lb		N.A.		N.A.	
	7 mm 3 Nm 2.2 ft-lb		7 mm 4 Nm 2.9 ft-lb		N.A.		3.5 mm 0.5 Nm max 4.4 in-lb max	

03174-C

75 °C Wire – Use copper conductors only.

Specifications

SAF 202 – XXX – YY – ZZZ

kW @ 400 VAC, 40 °C
Power Rating

(L1, L2, L3)
Mains Supply

(A1, A2, A3)
Control Supply

Model	kW @ 400 VAC	A	AC53b
015	15	34 A	AC53b 4-6:354
022	22	48 A	AC53b 4-6:354
030	30	60 A	AC53b 4-6:354
037	37	75 A	AC53b 4-6:594
045	45	85 A	AC53b 4-6:594
055	55	100 A	AC53b 4-6:594
075	75	140 A	AC53b 4-6:594
090	90	170 A	AC53b 4-6:594
110	110	200 A	AC53b 4-6:594

T4	3Ø, 200-440 VAC 45-66 Hz
----	-----------------------------

CV3	110-240 VAC & 380-440 VAC
-----	------------------------------

Wiring

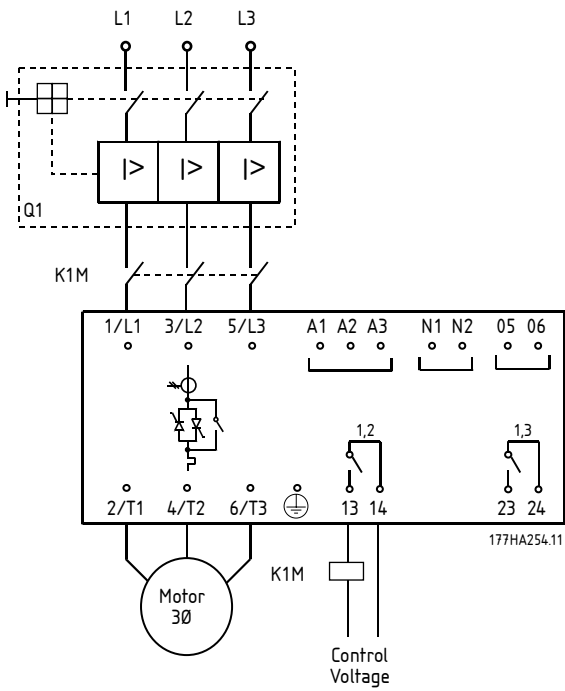

¹ 6 A @ 30 VDC resistive / 2 A 400 VAC, AC11

² Main Contactor

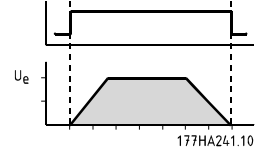

³ Auxiliary Relay Function = Trip

Semiconductor fuses can be used with the SAF 202 soft starter to reduce the potential for damage to SCRs from transient overload currents and for Type 2 coordination. Please refer to the Softdrive 200 Design Guide for fuse selection.

2 Wire

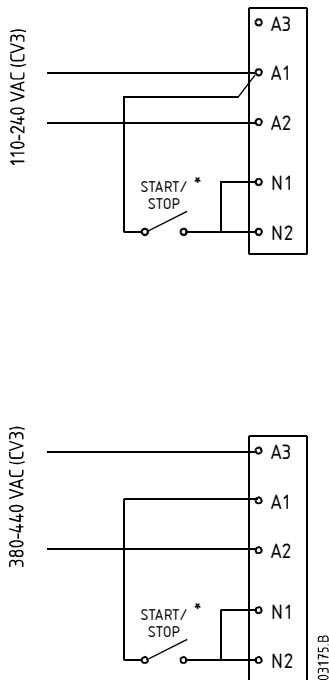

3 Wire

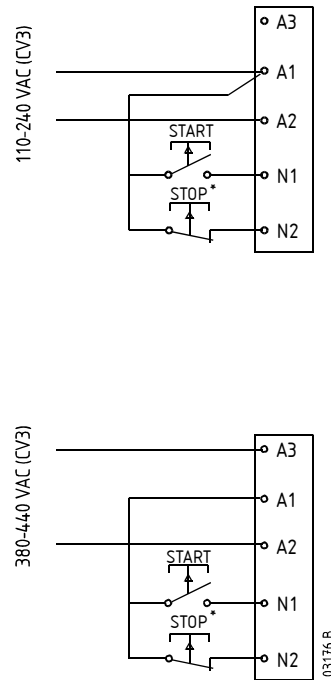

* Also resets trip conditions

Motor Thermistor

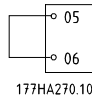

Or

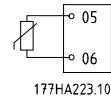

Always apply control voltage before (or with) mains voltage.









Disconnect from the power source before installing or servicing

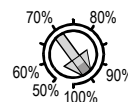
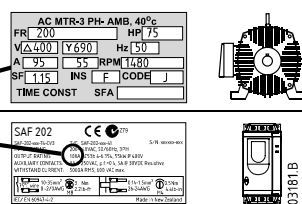
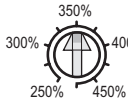
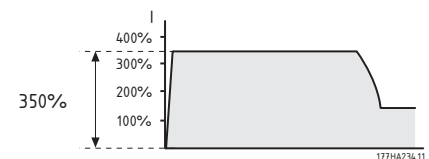

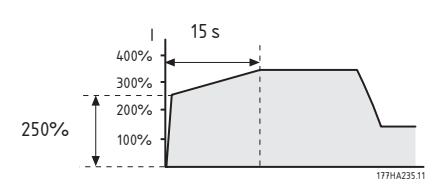
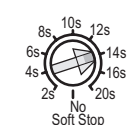
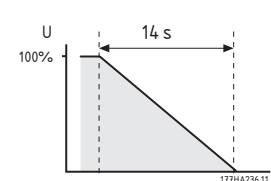
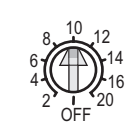
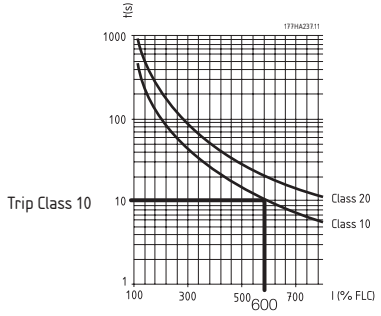
This product has been designed for Class A environments. Use of this product in domestic environments may cause radio interference.

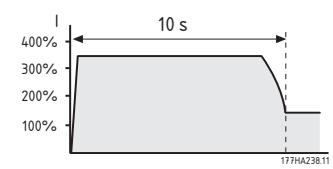
Adjustments

Par.	Example	
Motor FLC	 <p>Motor FLC (% SAF 202 FLC) 03360.A</p>	 <p>95% = $\frac{95A}{100A}$</p>
Current Limit	 <p>Current Limit (% Motor FLC) 177HA225.11</p>	 <p>350%</p>
Current Ramp	 <p>Current Ramp (%FLC / Ramp Time) 177HA226.11</p>	 <p>15 s</p>
Soft Stop	 <p>Soft Stop (seconds) 177HA227.11</p>	 <p>14 s</p>
Motor Trip Class	 <p>Motor Trip Class 177HA228.11</p>	 <p>Trip Class 10</p>
Excess Start Time	 <p>Excess Start Time (seconds) 177HA229.11</p>	 <p>10 s</p>

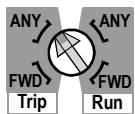
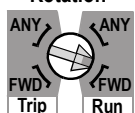
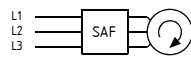
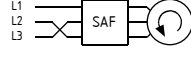
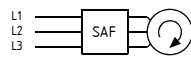
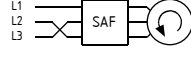
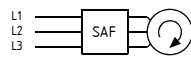
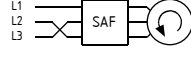
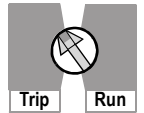
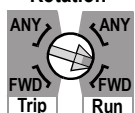
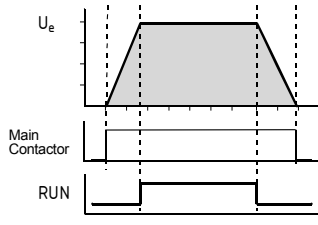
<p>Phase Rotation Protection</p>	 <p>177HA230.10</p> <p>Phase Rotation Protection</p>	<p>Phase Rotation = ANY 177HA232.10</p>  <p>Aux Relay = Trip</p> <p>Phase Rotation = FWD</p>  <p>Aux Relay = Run</p>	<table border="1"> <thead> <tr> <th></th> <th>FWD</th> <th>ANY</th> </tr> </thead> <tbody> <tr> <td>  </td> <td>✓</td> <td>✓</td> </tr> <tr> <td>  </td> <td>✗</td> <td>✓</td> </tr> </tbody> </table>		FWD	ANY		✓	✓		✗	✓
	FWD	ANY										
	✓	✓										
	✗	✓										
<p>Auxiliary Relay Function</p>	 <p>177HA231.10</p> <p>Aux Relay</p>	<p>Phase Rotation = FWD</p>  <p>Aux Relay = Run</p>	 <p>177HA240.11</p>									

Indication

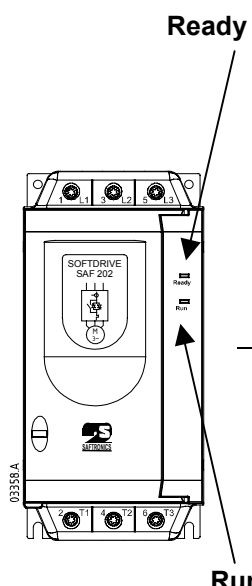
	○ Off	● On	☼ Flash
	No control power	Ready	Starter tripped
	Motor not running	Motor running at full speed	Motor starting or stopping

Troubleshooting

Ready	Description
☼ x 1	Power Circuit: Check mains supply L1, L2 and L3, motor circuit T1, T2 and T3 and soft starter SCRs.
☼ x 2	Excess Start Time: Check load, increase Current Limit or adjust Excess Start Time setting.
☼ x 3	Motor Overload: Allow motor to cool, reset soft starter and restart. Soft starter cannot be reset until motor has cooled.
☼ x 4	Motor Thermistor: Check motor ventilation and thermistor connection 05 and 06. Allow motor to cool.
☼ x 5	Phase Imbalance: Check line current L1, L2 and L3.
☼ x 6	Supply Frequency: Check supply frequency is in range.
☼ x 7	Phase Rotation: Check for correct phase rotation.
☼ x 8	Network Comms Failure (between accessory module and network): Check network connections and settings.
☼ x 9	Starter Comms Failure (between starter and accessory module): Remove and refit accessory module.